



DAVIES PUMPS
SINCE 1931

HYDROGENIE 8



Intelligent
Controller



Run dry protection



Instantaneous
digital readout

Owners Manual

Dear Client

Congratulations on your purchase of a **Hydrogenie 8** Electronic VFD Pump Controller. Please carefully read the following instruction and installation guide to ensure this is set up correctly to give a long and trouble-free service life.

Please check that your controller is the correct model for your application and that it has not sustained any damage during transit. Notify your supplier if you have any questions.

Introduction

The **HydroGenie 8** is an electronic pump controller with a variable frequency inverter, pressure transducer and flow sensor to manage a single or three phase pump up to 10A 2.2Kw (3.0Hp) and maintain constant pressure as well as protect from run dry failure and overload. The inverter also provides soft start/stop of the motor to prevent water hammer and increase motor life and provides energy savings by operating the pump only at the required speed necessary to maintain set pressure.

The **HG8** can also be configured as a pair with master/slave operation to control two pumps with alternate starting and operation. It can also be installed in a group of up to four units with communication via a central communication device.

The **HG8** has a simple and intuitive set up and operation menu which can be easily accessed via the control panel with push buttons, LED indication lights and LCD screen.

The LCD screen shows the pump operating data including line pressure, set pressure, the instantaneous current consumption and speed of the motor and flow activation. It also shows alarms when they occur.

The overload can be adjusted and set to protect the pump motor.

The controller has ART (Auto Reset Test) function which will automatically attempt to restore operation after a run dry or over current failure. Parameters will remain set even if power supply is interrupted.

The AIS function will periodically start the pump if temperatures drop below 5 degrees to reduce pump freezing. If temperatures drop below 0 degrees, then separate protection measures must be taken.

Alarm register records system failures, connection attempts and run hours, an optional volt free contact for monitoring alarms can be fitted.

These is a separate contact for a low-level float switch cut out.

CLASSIFICATION AND TYPE

According to IEC 60730-1 and EN 60730-1 this unit is a control electronic device for pressure systems of independent

assembly, action type 1Y (transistor output). Operating value: flow 2.5 l/min. Degree of contamination 2 (clean environment).

Impulse rating voltage: cat II / 2500V. Applied temperature for the ball pressure test: enclosure (75°C) and PCB (125°C).

According to EN 61800-3 the unit is class C2

Index

Technical Features..... 4
 Electrical Installation 6
 Main Connection 7
 Master Slave Connection 8
 Control Panel Layout 9
 Start up configurations 10
 Basic menu configurations 11
 Warning and Alarm..... 12
 Register 14
 Warranty..... 15



Technical Features:

Rated motor power: 0.37-2.2Kw

Supply Voltage: 1- 230V

Output Voltage: 1- 230V/3- 230V

Frequency: 50-60Hz

Max. Current per Phase: 10 A (~3 230 V) / 9A (~1 230 V)

Max. Peak Current: 20% for 10s

Fuses: 20A for inverter and 10A for main supply.

Protection: IP55*

Max. Water Temp/Ambient: 40 °C /50 °C

Max. Set pressure: 12 Bar

Max. Operating pressure: 15 Bar

Max. Flow: 15,000 L/H

Hydraulic Connection: 1.25" Male Net Weight: 3.3kg

* Dependent on cable glands being installed correctly.

Hydraulic Installation

The pump must have a non-return valve on the suction port and be correctly primed before completing hydraulic installation.

The internal flow sensor will protect pump from dry running but not loss of prime. It is recommended to install the external level cut out switch to prevent loss of prime especially if the pump has a suction lift. - see configuration menu.

The controller must be installed in a vertical position and the 1/4" inlet opening connected to the pump pressure port and the 1/4" outlet opening connected to the hydraulic network.

It is recommended to install a union between the pump and controller and an isolating ball valve after the controller to assist with future maintenance.

For pumps installed as a pair, the outlets must be manifolded together to ensure each unit is monitoring the same line pressure.



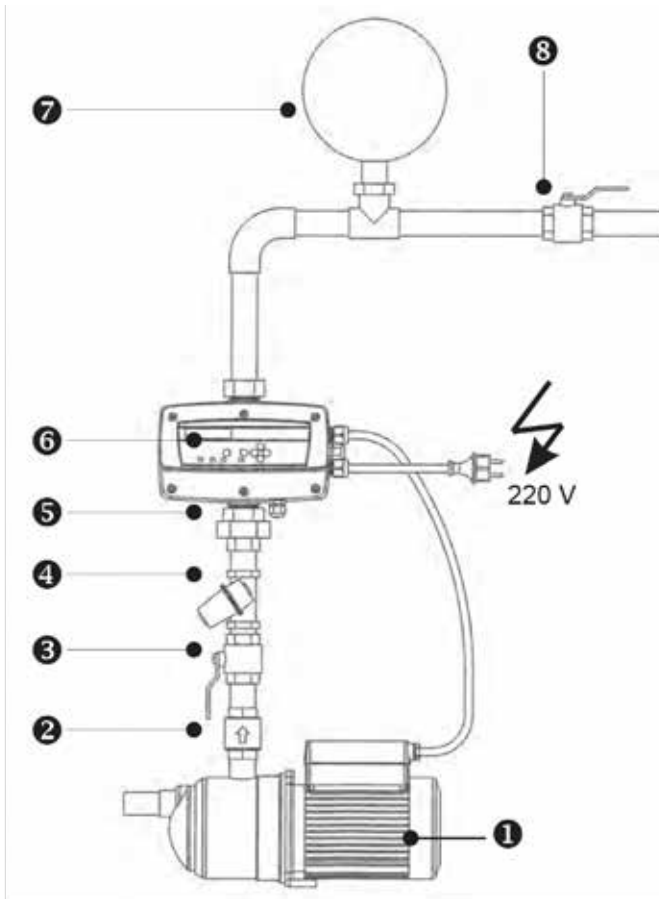

1. Pump.
2. Check Valve
3. Ball Valve
4. Filter
5. Union
6. HG8 Controller
7. Pressure Tank
8. Ball valve

Electrical Installation

WARNING: All connections must be done by qualified personal in accordance with all National electrical codes. Ensure all wiring is disconnected from mains supply before installation. Earth connections must be done first.

Please wait at least 2 minutes before doing any connections inside the controller to avoid electrical discharges.

The controller is not supplied with cables or plugs. Use cables with enough section to power requirements. Minimum of 3G1.5 for 230V mains supply and 3G1.0 for 230V motor supply (depending on cable length)

Ensure power is switched off and isolated before removing covers and doing any connections.

Ensure three phase motors are in low voltage connection (230V Delta).

Remove the main cover from controller and follow the indications on strip connectors.

Fit gland cap and seal to motor supply lead and feed lead through the upper cable gland and do connections: Single phase – Earth, U, V / Three phase – Earth, U, V, W. Tighten the gland cap firmly to prevent water ingress.

Fit gland cap and seal to mains supply lead and feed lead through lower cable gland and do connections: Single phase – Earth, L1, L2. Tighten the gland cap firmly to prevent water ingress.

The HG8 has the option to add a volt free contact with 1A max current to transmit a signal to an alarm box for audio or visual reference in case of a failure as detected by the controller. Please contact your supplier if you require this.

It also has a low-level input for a float switch to switch the pump off when supply is low to prevent loss of prime.

For master/slave connection, use the 4GX0.25 communication cable inserted through the lower gland. Follow connection diagram including crossing over of (Tx/Rx) between units. Refit the main cover, ensure the seal is fitted, cables are not pinched and screws are firmly tightened to maintain IP rating. Warranty may be voided by damage caused by incorrect connections.

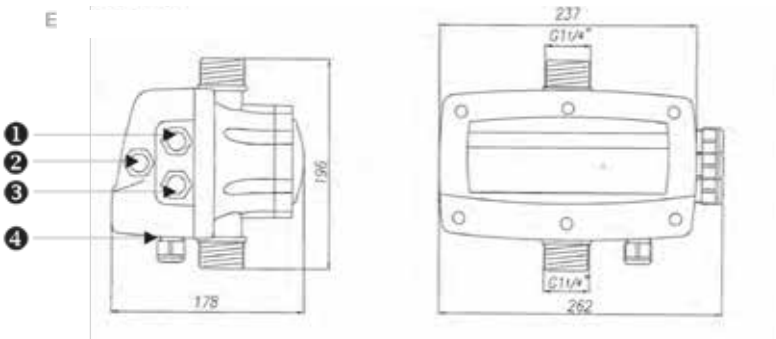

1. Pump Motor Supply
2. Minimum Level
3. Power Supply
4. Master/Slave Communication

Main Connection Diagram:

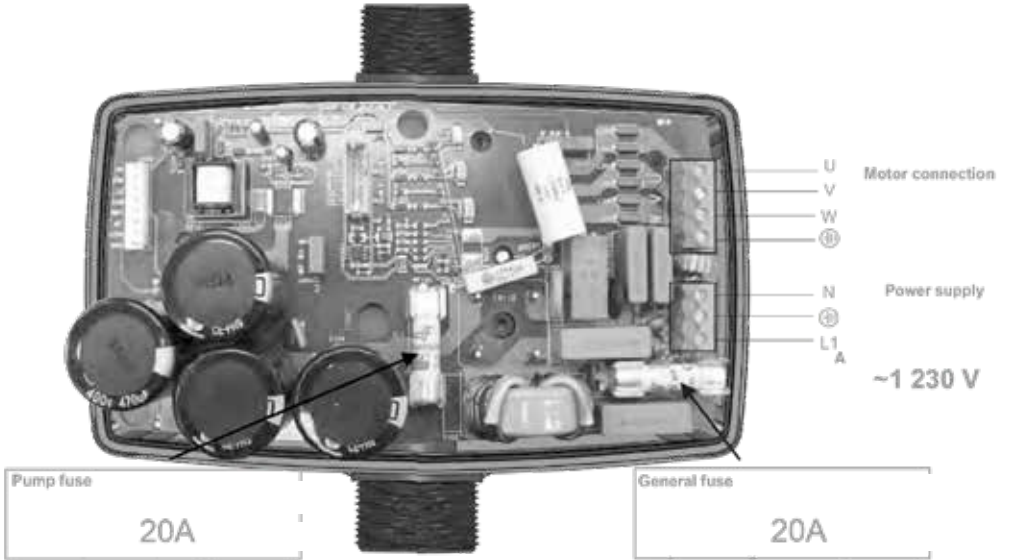

Motor Lead Connections:



Master/Slave Connection: Low Level cut out

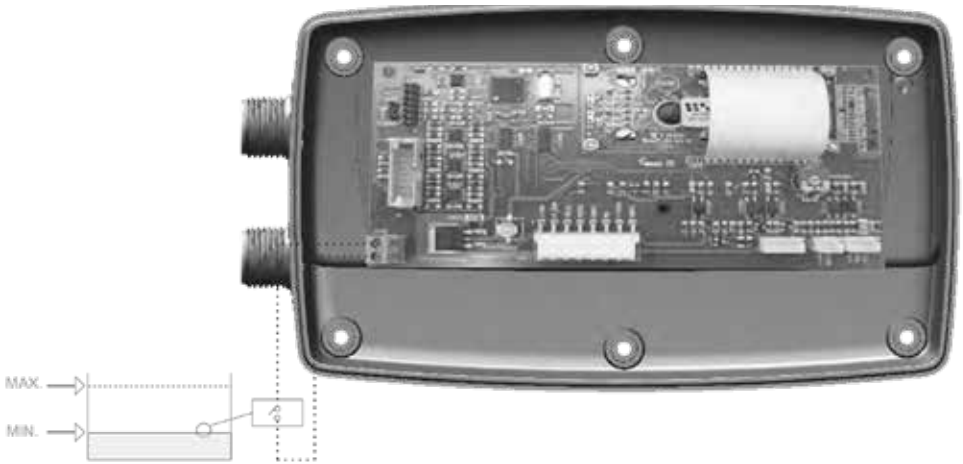

Unit 1	Unit 2
1 - Blue (+15V)	1 - Blue (+15V)
2 - Brown (Tx)	2 - Grey (Tx)
3 - Grey (Rx)	3 - Brown (Rx)
4 - Black (Gnd)	4 - Black (Gnd)

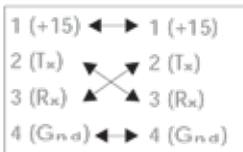

Note. Tx/Rx Connections must be swapped over between units.

Control Panel Layout:

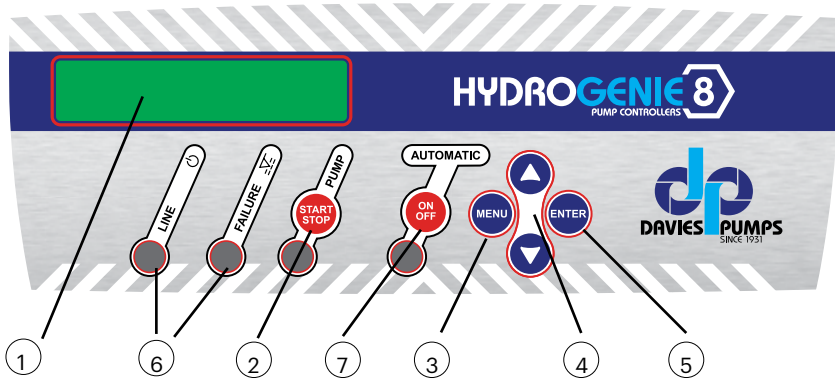

- 1 **LCD** screen. Shows the pressure in working mode.
- 2 **MANUAL START-STOP** push button.
- 3 Push button for **ENTER** or **EXIT** menu.
- 4 With these push buttons we can change programming values showed in the LCD screen (1).
- 5 **ENTER** for saving programmed values. Every press will go to the next field of the **CONFIGURATION MENU**. Whenever we want to quit the configuration sequence press **MENU** (3).
- 6 • **Led lights:**
 - **LINE** green: Electric supply. **ON** when it is connected.
 - **FAILURE** red: Bright or intermitten depending on type of failure.
 - **PUMP** yellow: When it is bright means pump working. It is lit with the pump stopped or when the device is not connected.
 - **AUTOMATIC** green: it is bright in **AUTOMATIC** mode . When it is intermitten in **MASTER&SLAVE** mode it means that this device will be auxiliary in the following cycle .
- 7 **ON/OFF**: It allows to change from **AUTOMATIC** to MANUAL mode or vice versa.

START UP:

Connect the **HG8** to the electric supply with the mains switch. Wait for 10 seconds while the HG8 is running auto test.

The **HG8** is supplied for connection to a three-phase motor as default. If it is running a single-phase motor, please follow motor configuration menu:

1. Press and hold 'Menu + Enter' buttons for 3s to open the expert menu. This menu allows the integration/acceleration/deceleration and motor supply to be set. It is not recommended to change these parameters.
2. Press 'Enter' three times to confirm initial values, then use the buttons to select 'single-phase' or 'three-phase' and push enter to confirm.











3. Disconnect from the power supply until the screen goes blank, re-connect to power supply.
 - If the unit is started for the first time, it will directly open the configuration menu. The LCD screen will display a message for language selection. Choose your language and start the configuration procedure see CONFIGURATION.
 - Once the unit is configured, switch to manual mode by pressing the AUTO On/Off push-button (green LED off). Verify if the pump is correctly primed using the Start/Stop push-button.
 - Press AUTO On/off. The unit is ready to operate.
 - Set up and configuration is the same for master/slave operation – each unit must be set up with identical parameters and the type of operation is selected during set up.

CONFIGURATION:

Press and hold the 'Menu' button to enter configuration menu and use $\uparrow\downarrow$ buttons to change the values and press ENTER for validation. After every ENTER, the next screen setting for the configuration sequence appears. Whenever we want to quit the configuration sequence, press MENU.

No.	Screen	Description	
0	PLINE PON 03,0 bar 02,0 bar	Push MENU for 3 seconds to start configuration sequence.	3s
1	SET UP MENU	This temporary message gives information about the software version.	3s
2	LANGUAGE ENGLISH	By mean of keys $\uparrow\downarrow$ we can choose the languages: "LANGUAGE ENGLISH", "LANGUE FRANÇAISE", "LINGUA ITALIANA" and "IDIOMA ESPAÑOL"	
3	INT. MAX. OFF 0.0	The rated current intensity of pump motor - from 0 to 10 A - is entered by means of the $\uparrow\downarrow$ keys to enable thermal protection of the motor. This value is given on the name plate of the motor. Press ENTER to confirm.	
4	ROTATION SENSE 0 Hz	Using the START/STOP pushbutton verify the rotation sense of three-phase motor. By mean of keys $\uparrow\downarrow$ (0/1) we can change it. Press ENTER for validation.	

No.	Screen	Description	
5	MIN. SPEED 15 Hz	Using $\uparrow\downarrow$ we can increase the lower limit of the speed of rotation of the pump's motor.	
6	LEVEL PROBE NO	If there is no external device for detecting the minimum water level, press ENTER to confirm. Otherwise, change NO for YES using the $\uparrow\downarrow$ keys	
7	PROGRAMMING	Being inside configuration menu we are having access to the main program section.	
8	SET POINT 2,0 bar	This will be the system operating pressure. Use keys $\uparrow\downarrow$ to modify the initial value (2 bar). WARNING! The set pressure must be at least 1 bar lower than the maximum pressure of the pump. NOTE: In case of group assembly, the system operates at the pressure set in the MASTER device so that the configuration of set pressure in the slave device is superfluous.	
9	DIF. START 0,3 bar	The default value is 0,3 bar. This value of pressure is the one that the system will subtract from the set pressure before the system starts when the hydraulic network has a demand. Using keys $\uparrow\downarrow$ to modify the initial value. It is recommended to maintain this value between 0,3 and 0,6 bar. Example: - Input pressure: 2 bar. - Differential start: 0,3 bar. - Final start pressure: 2 - 0,3 = 1,7 bar.	
10	TIMER STOP 5	TIMER STOP default value is 5". This will be the time the system will run for after the usage in the whole installation has stopped. Using keys $\uparrow\downarrow$ we can modify the initial value.	
11	VIEW MODE NORMAL	There are 2 view modes to choose: - NORMAL: it is visualized "P LINE" (real pressure of the installation) and "INPUT P" (configured pressure). - SERVICE: it is visualized "Hz" (working frequency of the inverter), "REF" (configured pressure), "PRESS" (real pressure of the installation) and "FL" (flow sensor state).	
12	SERIAL CONTROL SLAVE	The HG8 is configured by default as "SLAVE", with individual assembly just confirm "SLAVE" by pushing ENTER. In case of a pair with master/slave, change one unit to "MASTER" by pushing \downarrow and leave the other as 'slave'. It does not matter which unit is master. In case of assembly of more than 2 devices, we will change all units from "SLAVE" to "SWITCHER" by pushing \downarrow twice - see instructions for communication centre.	
13	DIRECTION CH 1	It allows to set the communication channel for a group assembly. Push ENTER.	
14	P LINE INPUT P 00,0 bar 00,0	After pressing ENTER pushbutton, the system is configured showing the type of view chosen in the previous section, Press AUTOMATIC in order to start automatic operation. In case of group assembly press AUTOMATIC only in the device configured as MASTER. In case of group assembly, after pressing AUTOMATIC in the MASTER device, the AUTOMATIC LED LIGHT of the SLAVE device will start to flash intermittently, indicating that communication between both devices is ready. If this does not happen verify the connections are correct.	

ALARMS:

In case of simultaneous alarms, quit the automatic mode by pressing the pushbutton 'AUTOMATIC ON/OFF' (led light PUMP will turn off). The successive alarms will be displayed by using the $\uparrow\downarrow$ buttons to scroll. Once viewed, leave the menu by pressing ENTER and returning to MANUAL mode.

Failure – LED Indication ● or ★	Description	System Reaction	Solution
A1 DRY RUNNING ★ Failure verification ● Final failure	If the system detects dry running for more than 10 seconds, it will stop the pump and the ART (Automatic Reset Test) will be activated	After 5 minutes ART system will start the pump for 30 seconds, trying to restore the system. If prime is not restored, it will try it again every 30 minutes for 24 hours. If after all these cycles the system still detects lack of water, the pumps will remain permanently out of order until the damage will be repaired.	Check the water supply, suction pipe and pump prime. The pumps can be primed manually using the push-button START/STOP (the led light AUTOMATIC should be off, if it is not, press the push-button to disable it). Special case: If the pump cannot provide the programmed pressure (configuration mistake) the HG8 reacts as it was dry-running.
A2 OVER-INTENSITY ★ Failure verification ● Final failure	The motor is protected against over currents by means of the intensity values established in the installation menu. These over currents are produced generally by malfunctions in the pump or in the electric supply.	When overcurrent is detected, the pump will automatically stop. The system will try to restart the pump when demand requires it. The control system will carry out 4 attempts to restore in this circumstance. After the 4th attempt, the pump will remain definitively out of order.	Check the state of the pump, for example the impeller could be blocked. Check intensity values set in the configuration menu.
A3 DISCONNECTED P. ● Final failure	The HG8 has an electronic safety system to protect against short circuits as well as a 20 A fuse.	The device is disconnected.	The insulation of the motor and the pump consumption should be checked. Check the 20 A fuse – if it has blown contact your supplier.
A5 TRANSDUCER ● Final failure	The transducer damages are showed in the HG8's LCD screen.	The device operation is interrupted.	Contact your supplier.
A6 EXCESSIVE TEMP. ● Final failure	The system has a cooling device to keep the INVERTER in optimum working condition.	If an excessive temperature is reached the system shuts down.	Check the temperature of the water, it should be under 40 °C and the temperature environment should be under 50 °C.

Failure – LED Indication ● or ★	Description	System Reaction	Solution
A7 SHORTCIRCUIT ● Final failure	The HG8 has an electronic safety system to protect against short circuits as well as a 20 A fuse.	The pump remains stopped for 10". Then it starts again with 4 attempts. If the problem is not solved, the pump will remain definitively out of order.	Check the pump and wiring connections, if the problem persists, contact your supplier.
A8 OVERVOLTAGE ● Failure verification	The HG8 has an electronic safety system against over voltages.	In case of overvoltage the system remains stopped until an adequate value of voltage is reached. In this case, the system is automatically restored.	Check the electric supply.
A9 UNDERVOLTAGE ● Failure verification	The HG8 has an electronic safety system against too low supply voltages.	In case of undervoltage the system remains stopped until an adequate value of voltage is reached. In this case, the system is automatically restored.	Check the electric supply.
BLANK SCREEN	BLANK SCREEN		Check the electric supply 230 V. If this is correct, check the general fuse (20 A), located in the main plate.

ALARMS FOR GROUP ASSEMBLY:

The alarms for assembled devices, are similar to those of the individual one with the specific particularities of operation with 2 communicated devices. Depending on the system’s reaction there are 4 types of alarm:

- 1 COMMUNICATION FAILURE:** no alarm is activated. Both devices continue operating independently as single units.
- 2 LACK OF WATER:** if there is a lack of water alarm in a single pump, the other one assumes the role of “main device”, if there is an over-demand during next working cycles, the system will try to restore the device in failure. If the device is restored in these conditions then it will be also restored the alternated working mode. If there is lack of water on both devices, the system will activate the **ART** system in the **MASTER** unit.
- 3 MINIMAL LEVEL IN THE TANK:** the alarm “**LACK OF WATER**” is activated and the device remains in failure. It will be automatically restored when the level sensor detects water again.
- 4 REST OF ALARMS:** If the alarm has occurred in a single device, the other will act as “main device”. The system will try to restore the disabled device only in case of over demand, after 4 successive attempts without success the device is turned off, it should be restored manually. In case of alarms in both devices the system performs 4 restore attempts, if it does not succeed the system is disabled.

To restore manually a device disabled by an alarm push **AUTOMATIC ON / OFF** in **MASTER** device and then **ENTER** in the device with the alarm.

REGISTER OF OPERATION DATA AND ALARMS.

By simultaneously pressing MENU+ ↵ for 3", the REGISTER OF OPERATION DATA AND ALARMS is opened, by mean of ENTER we can advance through the sequence, once finished the sequence we come back to the main display. This is all the sequence:

Register of alarms

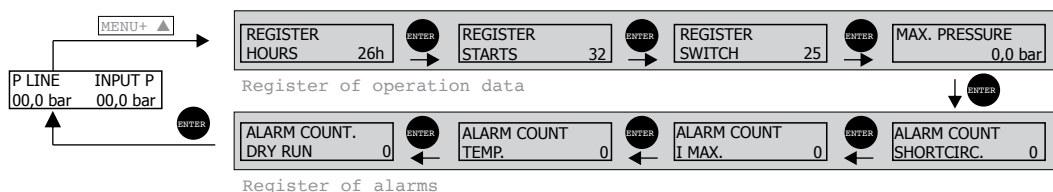

REGISTER HOURS. Counter of total time that the pump has been operating.

REGISTER STARTS. Number of cycles of operation, a cycle is a start and a stop.

REGISTER SWITCH. Number of connections to the electric supply.

MAX PRESSURE. Maximum pressure reached by the installation. It allows the detection of water hammer.

ALARM COUNT. SHORTCIRC. Number of short circuit alarms.

ALARM COUNT I MAX. Number of overcurrent alarms.

ALARM COUNT. TEMP. Number of alarms by excessive temperature.

ALARM COUNT DRY RUN. Number of dry-running alarms.

All the records are saved even if the device has been disconnected from the electric supply.

"CE" STATEMENT OF COMPLIANCE.

COELBO CONTROL SYSTEM. We state, on our's own responsibility, thal all materials here-with related comply with the following

European standards:

2006/95/EC Low Voltage Directive on Electrical Safety

2004/108/CE Electromagnetic Compatibility.

2002/95/CE RoHS Directive

Product's name/Type: **HYDROGENIE 8**

As per the European Standards:

UNE EN 60730-1:1998+A11:1998+A2:1998+A14:1998+A15:1998+A16:1998+A17:2001

UNE EN 60730-2-6:1997+A1:1998+A2:1999+CORR A1:2001+CORR A2:01

UNE EN 61000-6-2:2002

UNE-EN 61000-6-4:2002

UNE-EN 61000-3-2:2001

Warranty Policy for Davies Pump Controllers

Your Davies Pump Controller, when used for its designed purpose should give you years of trouble free service. Please take the time to read and understand the operator's manual for this product before installing and operating. Failure to install and operate as per the operation instructions will render warranty on this unit void.

Davies Pump Controllers are warranted to be free of material and manufacturing defects at the time of purchase. Warranty Period: 2 Years from date of purchase.

This warranty is limited to the cost of the product and does not cover travel charges, removal and re-installation charges, consumables, Electrician or Plumbers charges or any other third party costs

unless authorized by Argon Distributors prior to being carried out.

Argon distributors will repair or replace for the consumer any portion of the failed item which has proved to be defective within the warranty period. Replacement product or parts may include refurbished parts or components.

The warranty does not cover Damage or malfunction resulting from:

- A. Misuse, accident, fire, water, lightning, negligence, abuse, product modifications.
- B. Repairs or attempted repairs by unauthorized persons
- C. Damages to product caused by transit
- D. Removal or installation of the product
- E. Normal wear and tear.
- F. Water and Insect ingress
- G. Exposure to corrosive conditions
- H. Foreign objects in the liquid being pumped
- I. Electrical power fluctuations
- J. Freight

Argon Distributors liability is limited to the cost of the product and shall not be liable for:

- A. Damage to other property caused by defects in the product.
- B. Loss of use of the product.
- C. Loss of time, loss of profits, loss of business opportunity, loss of goodwill
- D. Any other damages incidental, consequential or otherwise.
- E. Claims under this warranty must give evidence of the Date of purchase, Invoice Copy, Model, Serial Number, photos and information of the installation as soon as the failure has occurred.

Owner's detail must be noted.

If any of the above is unclear please contact your supplier or warranty manager at ARGON DISTRIBUTORS.

Proven solutions through experience

ARGON
DISTRIBUTORS LTD



argondistributors.co.nz